



Model number

INY360D-F99-2I2E2-V17

Features

- E1-Type approval
- Measuring range 0 ... 360°
- Analog output 4 mA ... 20 mA
- Evaluation limits can be taught-in
- 2 programmable switch outputs
- High shock resistance
- Increased noise immunity 100 V/m

Electrical connection

Standard symbol/Connection:

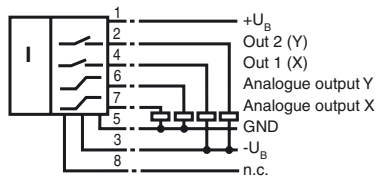

Technical Data

General specifications

Type	Inclination sensor, 2-axis
Measurement range	0 ... 360 °
Absolute accuracy	≤ ± 0.5 °
Response delay	≤ 25 ms
Resolution	≤ 0.1 °
Repeat accuracy	≤ ± 0.1 °
Temperature influence	≤ 0.027 °/K

Functional safety related parameters

MTTF _d	300 a
Mission Time (T _M)	20 a
Diagnostic Coverage (DC)	0 %

Indicators/operating means

Operation indicator	LED, green
Teach-In indicator	2 LEDs yellow (switching status), flashing
Button	2 push-buttons (Switch points programming , Evaluation range programming)
Switching state	2 yellow LEDs: Switching status (each output)

Electrical specifications

Operating voltage U _B	10 ... 30 V DC
No-load supply current I ₀	≤ 25 mA
Time delay before availability t _v	≤ 200 ms

Switching output

Output type	2 switch outputs PNP, NO , reverse polarity protected , short-circuit protected
Operating current I _L	≤ 100 mA
Voltage drop	≤ 3 V

Analog output

Output type	2 current outputs 4 ... 20 mA (one output for each axis)
Load resistor	0 ... 200 Ω at U _B = 10 ... 18 V 0 ... 500 Ω at U _B = 18 ... 30 V

Ambient conditions

Ambient temperature	-40 ... 85 °C (-40 ... 185 °F)
Storage temperature	-40 ... 85 °C (-40 ... 185 °F)

Mechanical specifications

Connection type	8-pin, M12 x 1 connector
Housing material	PA
Degree of protection	IP68 / IP69K
Mass	240 g

Factory settings

Analog output (X)	-45 ° ... 45 °
Analog output (Y)	-45 ° ... 45 °
Switching output (X)	-30 ° ... 30 °
Switching output (Y)	-30 ° ... 30 °

Compliance with standards and directives

Standard conformity	
Shock and impact resistance	100 g according to DIN EN 60068-2-27
Standards	EN 60947-5-2:2007 IEC 60947-5-2:2007

Approvals and certificates

UL approval	cULus Listed, Class 2 Power Source
CSA approval	cCSAus Listed, General Purpose, Class 2 Power Source
E1 Type approval	10R-04

EMC Properties

Interference immunity in accordance with
DIN ISO 11452-2: 100 V/m
Frequency band 20 MHz up to 2 GHz
Mains-borne interference in accordance with ISO 7637-2:

Pulse	1	2a	2b	3a	3b	4
Severity level	III	III	III	III	III	III
Failure criterion	C	A	C	A	A	C

EN 61000-4-2: CD: 8 kV / AD: 15 kV

Severity level IV IV
EN 61000-4-3: 30 V/m (80...2500 MHz)
Severity level IV

EN 61000-4-4: 2 kV
Severity level III
EN 61000-4-6: 10 V (0.01...80 MHz)
Severity level III

EN 55011: Klasse A

Dimensions

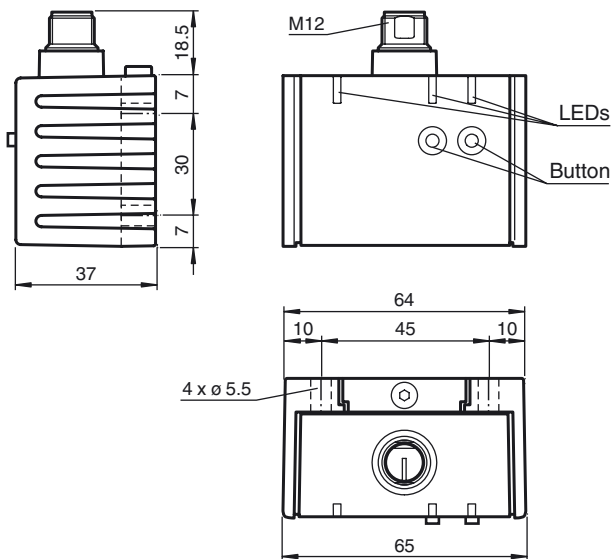

Sensor Orientation

In the default setting the zero position of the sensor is reached, when the electrical connection faces straight upwards.

X Orientation

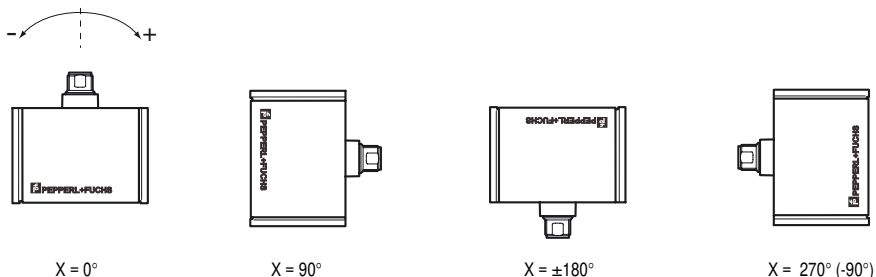

Y Orientation

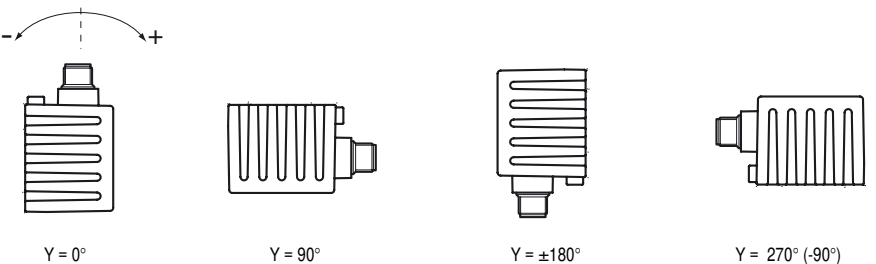

Mounting of the sensor

Sensors from the -F99 series consist of a sensor module and accompanying cast aluminum housing. Select a vertical surface with minimum dimensions of 70 mm x 50 mm to mount the sensor. Mount the sensor as follows:

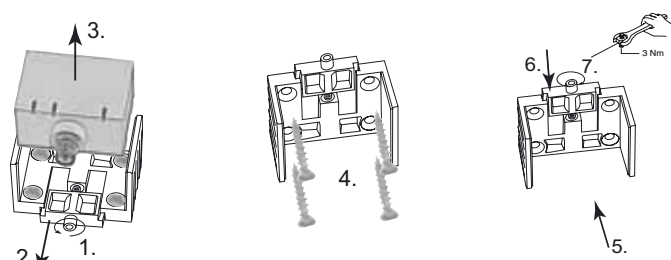

1. Loosen the central screw under the sensor connection.

Pinout

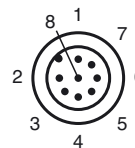

Wire colors

1	WH	(white)
2	BN	(brown)
3	GN	(green)
4	YE	(yellow)
5	GY	(gray)
6	PK	(pink)
7	BU	(blue)
8	RD	(red)

Accessories

V17-G-2M-PUR

Female cordset, M12, 8-pin, shielded, PUR cable

V17-G-5M-PUR

Female cordset, M12, 8-pin, shielded, PUR cable

V17-G-10M-PUR

Female cordset, M12, 8-pin, shielded, PUR cable

V17-G-10M-PVC-ABG

Female cordset, M12, 8-pin, shielded, PVC cable

2. Slide back the clamping element until you are able to remove the sensor module from the housing.
3. Remove the sensor module from the housing
4. Position the housing at the required mounting location and secure using four countersunk screws. Make sure that the heads of the screws do not protrude.
5. Place the sensor module in the housing.
6. Slide the clamping element flush into the housing. Check that the sensor element is seated correctly.
7. Finally tighten the central screw.

The sensor is now mounted correctly.

LED display

Displays dependent on the operating state	LED green: Power	LED yellow out 1	LED yellow out 2
Teach-in of switching points (X-axis):	off	flashes	off
Teach-in of switching points (Y-axis):	off	off	flashes
Activate teach-in mode for analog limits:	off	flashes	flashes
Teach-in of analog limit (X-axis)	off	flashes	off
Teach-in of analog limit (Y-axis)	off	off	flashes
Normal operation	on	switching- state	switching- state
Reset to factory settings: 2 s ... 10 s	off	flashes	flashes
> 10 s ... end of reset process	flashes	off	off
Followed by normal operation			
Undervoltage	flashes	off	off

Axis definition

The definition of the X-axis and Y-axis is shown on the sensor housing by means of imprinted and labeled double arrows.

Teach-in of switching points (X-axis)

1. Press key T1 > 2 s (see LED display)
2. Move sensor to switching position 1
3. Press key T1 briefly. LED "out 1" lights for 1.5 s as confirmation. Switching point 1 has been taught
4. Move sensor to switching position 2
5. Press key T1 briefly. LED "out 1" lights for 1.5 s as confirmation. Switching point 2 has been taught
6. Sensor returns to normal operation (see LED display)



The NC (active output state) is always defined in the range from the 1st configured position to 2nd configured position.

As an example :

Case #1: configure position #1 at +45degree, configure position #2 at +90 degree; NC is from +45 ' +90 in the CW direction

Case #2: configure position #1 at +90degree ; configure position #2 at +45 degree; NC is from +90 ' +45 in the CW direction

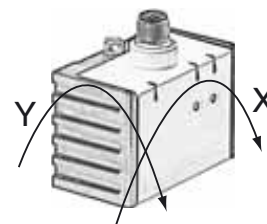

Teach-in of switching points (Y-axis)

1. Press key T2 > 2 s (see LED display)
2. Move sensor to switching position 1
3. Press key T2 briefly. LED "out 2" lights for 1.5 s as confirmation. Switching point 1 has been taught
4. Move sensor to switching position 2
5. Press key T2 briefly. LED "out 2" lights for 1.5 s as confirmation. Switching point 2 has been taught
6. Sensor returns to normal operation (see LED display)



The NC (active output state) is always defined in the range from the 1st configured position to 2nd configured position.

See also the example, above.

Teach-in of analog limits (X-axis)

1. Activate the teach-in mode for the analog limits by simultaneously pressing keys T1 and T2 > 2 s (see LED display)
2. Press key T1 > for 2 s (see LED display)
3. Move the sensor into the position of minimum evaluation limit
4. Press key T1 briefly. LED "out 1" lights for 1.5 s as confirmation. The minimum evaluation limit has been taught. In this position the analog output will provide its minimum output value.
5. Move the sensor into the position of maximum evaluation limit
6. Press key T1 briefly. LED "out 1" lights for 1.5 s as confirmation. The maximum evaluation limit has been taught. In this position the analog output will provide its maximum output value.
7. Sensor returns to normal operation (see LED display)



If the sensor inclination exceeds one of the analog limits, the last value of the analog output is retained.

Teach-in of analog limits (Y-axis)

1. Activate the teach-in mode for the analog limits by simultaneously pressing keys T1 and T2 > 2 s (see LED display)
2. Press key T2 > 2 s (see LED display)
3. Move the sensor into the position of minimum evaluation limit
4. Press key T2 briefly. LED "out 2" lights for 1.5 s as confirmation. The minimum evaluation limit has been taught. In this position the analog output will provide its minimum output value.
5. Move the sensor into the position of maximum evaluation limit
6. Press key T2 briefly. LED "out 2" lights for 1.5 s as confirmation. The maximum evaluation limit has been taught. In this position the analog output will provide its maximum output value.
7. Sensor returns to normal operation (see LED display)



If the sensor inclination exceeds one of the analog limits, the last value of the analog output is retained.

Resetting the sensor to factory settings

1. Press keys T1 and T2 > 10 s (see LED display)
2. The sensor has been reset when the green LED "Power" lights again after approx. 10 s.

Undervoltage detection

If the supply voltage falls below a value of approx. 7 V, all outputs and yellow LEDs are deactivated. The green "Power" LED flashes rapidly. If the supply voltage exceeds a value of approx. 8 V, the sensor continues with normal operation.