



Model Number

PMI810-F110-IU-V1

Features

- Analog output 0 V ... 10 V/4 mA ... 20 mA
- Measuring range 0 ... 810 mm

Technical data

General specifications

Switching element function	analog, current or voltage output
Object distance	max. 6 mm
Measurement range	0 ... 810 mm

Nominal ratings

Operating voltage U_B	18 ... 30 V DC
Reverse polarity protection	reverse polarity protected
Linearity error	± 0.8 mm
Repeat accuracy R	± 0.4 mm
Resolution	950 μ m
Temperature drift	± 1 mm (-25 °C ... 70 °C)
No-load supply current I_0	≤ 70 mA
Operating voltage indicator	LED green

Functional safety related parameters

MTTF _d	120 a
Mission Time (T _M)	20 a
Diagnostic Coverage (DC)	0 %

Analog output

Output type	1 current output: 4 ... 20 mA 1 voltage output: 0 ... 10 V
Load resistor	current output: $\leq 400 \Omega$ voltage output: $\geq 1000 \Omega$
Short-circuit protection	voltage output: pulsing

Ambient conditions

Ambient temperature	-25 ... 70 °C (-13 ... 158 °F)
---------------------	--------------------------------

Mechanical specifications

Connection type	4-pin, M12 x 1 connector
Housing length L	850 mm
Degree of protection	IP65
Material	
Housing	PA 6 / AL
Target	mild steel, e. g. 1.0037, SR235JR (formerly St37-2)
Note	The data relating to accuracy only apply to a distance to the object to be detected of 1 ... 6 mm. The path measurement system must be secured at 20 cm intervals to prevent mechanical load.

Compliance with standards and directives

Standard conformity	
Standards	EN 60947-5-2:2007 IEC 60947-5-2:2007

Approvals and certificates

UL approval	cULus Listed, General Purpose, Class 2 Power Source
CCC approval	CCC approval / marking not required for products rated ≤ 36 V

Dimensions

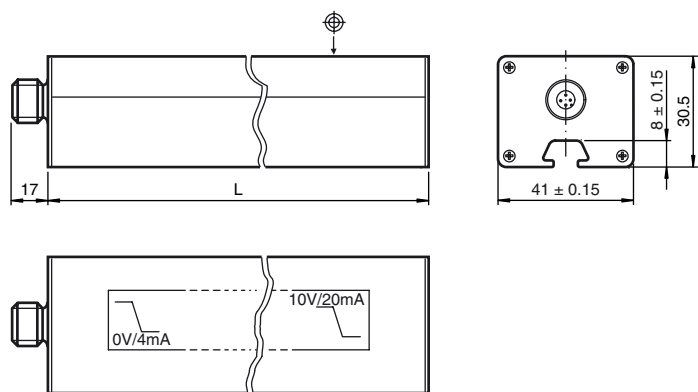

Release date: 2012-05-14 13:37 Date of issue: 2016-05-03 197524_eng.xml

Electrical Connection

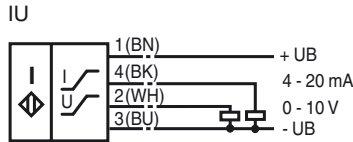

Core colours in accordance with EN 60947-5-2.

Pinout

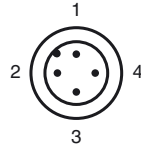

Wire colors in accordance with EN 60947-5-2

1	BN	(brown)
2	WH	(white)
3	BU	(blue)
4	BK	(black)

Accessories

BT-F110-G
Damping element for F110 housing sensors; front screw holes

BT-F110-W
Damping element for F110 housing sensors; lateral screw holes

V1-G-2M-PVC
Female cordset, M12, 4-pin, PVC cable

MH-F110
Mounting bracket for mounting F110 series sensors

Instruction manual

• **Security advice**



This product must not be used in applications, where safety of persons depend on the correct device function.
This product is not a safety device according to EC machinery directive.

• **Sensor Properties**

The inductive positioning system F110 provides both, a current and voltage signal at the outputs, which is proportional to the position of the attenuating element.
Output signals: 4 mA ... 20 mA and 0 V ... 10 V

• **Attenuating element**

The inductive position encoding system F110 is optimally adjusted to the geometry of the attenuating elements we offer (see accessories, below).

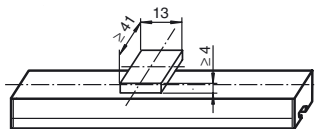

When using your own attenuating elements, you must ensure that the active surface of the attenuating element has a width of exactly 13 mm and overlaps the entire sensor width (41 mm).
A different width has a direct impact on the achievable resolution and accuracy of the system.

Spacing between sensor and attenuating element is from 0 ... 6 mm.
Sensing accuracy is guaranteed between 1 ... 6 mm..

• **Installation and operation**

Release date: 2012-05-14 13:37 Date of issue: 2016-05-03 197524_eng.xml

Notes on installation

- A flush installation is possible.
- Fixation and installation of the positioning system F110 is carried out by the use of t-slides. This provides a flexible adaptation to the field situation.
- The distance between the measuring field (bordered area at the front of the sensor) and the fixing base or fixing element of the attenuating element must at least be 6 mm.

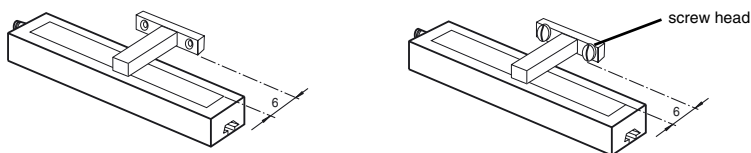

Notes on operation

The sensor accuracy can be guaranteed, when the spacing between attenuating element and sensor is within an interval of 1 ... 6 mm.

When the attenuating element leaves the measurement range (figures below):

- the last valid value is maintained at the voltage output until the attenuating element re-enters the valid range.
- the last valid value is maintained at the current output for 0.5 seconds. Afterwards, the output changes to a fault current of 3.6 mA until the attenuating element re-enters the valid range.

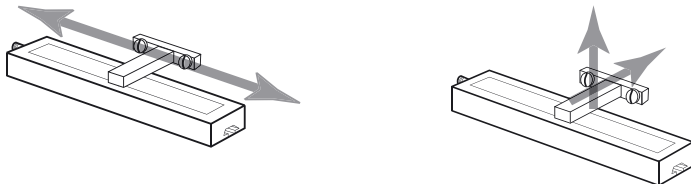

Definition of measuring range / of measured position

The measured attenuating elements (actuators) position refers to half its width (middle of the actuator). The measuring range starts and ends when the attenuating element overlaps the labeled measuring area on the sensor at transversal motion (see left figure above).

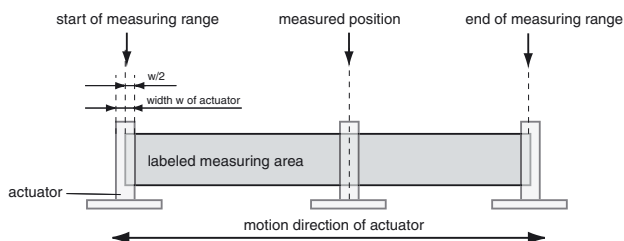

Accessories

Attenuating elements

BT-F110-G



BT-F110-W



Mounting brackets

MH-F110



Straight cables:

V1-G-2M-PVC (4 wire)

Angled cables:

V1-W-2M-PVC (4 wire)

Release date: 2012-05-14 13:37 Date of issue: 2016-05-03 197524_eng.xml