

Model Number

GLV18-8-450/73/120

Diffuse mode sensor
with 4-pin, M12 x 1 plastic connector

Features

- Efficient Line in a short M18 plastic housing for standard applications
- Very high detection range
- 4 LEDs indicator for 360° visibility
- Optimized potentiometer design for a clear control button layout in the application
- Version with front optical face
- DC voltage version

Product information

The GLV/GLK18 series sensors help improve the efficiency of machines and systems. The design of the M18 plastic housing, the connection technology, and sensor properties are highly standardized. Concentrating on the key sensor requirements has produced a robust and reliable product series for DC and AC/DC voltage systems without any over-engineering. The mounting set included in the scope of delivery and the optimized potentiometer design ensure fast assembly and easy configuration.

Release date: 2016-06-20 12:54 Date of issue: 2016-06-20 186567_eng.xml

Dimensions

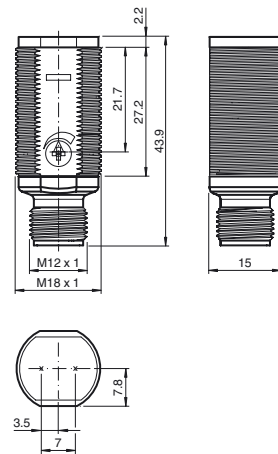

Electrical connection

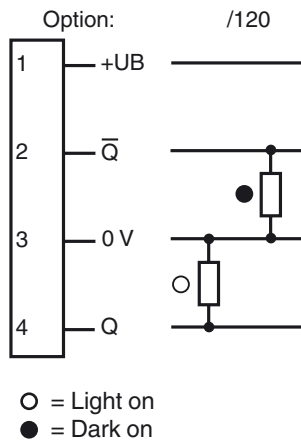

Pinout

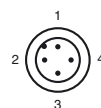

Wire colors in accordance with EN 60947-5-2

- 1 | BN (brown)
- 2 | WH (white)
- 3 | BU (blue)
- 4 | BK (black)

Indicators/operating means

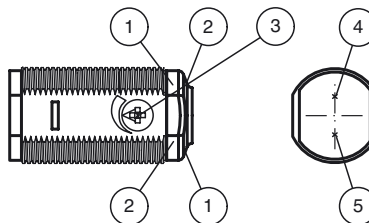

| | | |
|---|------------------------|--------|
| 1 | Operating display | green |
| 2 | Signal display | yellow |
| 3 | Sensitivity adjustment | |
| 4 | Emitter | |
| 5 | Receiver | |

Technical data**General specifications**

| | |
|----------------------------|--------------------------------------|
| Detection range | 50 ... 450 mm adjustable |
| Detection range max. | 0 ... 450 mm |
| Reference target | 100 mm x 100 mm Kodak white |
| Light source | LED |
| Light type | modulated visible red light , 640 nm |
| Diameter of the light spot | approx. 30 mm at 400 mm |
| Angle of divergence | approx. 4 ° |
| Optical face | frontal |
| Ambient light limit | 30000 Lux |
| Hysteresis | H < 15 % |

Functional safety related parameters

| | |
|--------------------------------|-------|
| MTTF _d | 920 a |
| Mission Time (T _M) | 20 a |
| Diagnostic Coverage (DC) | 0 % |

Indicators/operating means

| | |
|---------------------|--|
| Operation indicator | LED green, statically lit Power on |
| Function indicator | LED yellow: lights when object is detected ; flashes when falling short of the stability control |
| Control elements | sensitivity adjustment |

Electrical specifications

| | | |
|------------------------|----------------|----------------|
| Operating voltage | U _B | 10 ... 30 V DC |
| No-load supply current | I ₀ | < 20 mA |

Output

| | | |
|---------------------|--|------------|
| Switching type | light/dark on | |
| Signal output | 2 PNP, complementary, short-circuit protected, open collectors | |
| Switching voltage | max. 30 V DC | |
| Switching current | max. 100 mA | |
| Voltage drop | U _d | ≤ 1.5 V DC |
| Switching frequency | f | 500 Hz |
| Response time | | ≤ 1 ms |

Ambient conditions

| | |
|---------------------|--------------------------------|
| Ambient temperature | -25 ... 60 °C (-13 ... 140 °F) |
| Storage temperature | -40 ... 70 °C (-40 ... 158 °F) |

Mechanical specifications

| | |
|----------------------|--------------------------|
| Degree of protection | IP67 |
| Connection | 4-pin, M12 x 1 connector |
| Material | |
| Housing | PC |
| Optical face | PMMA |
| Connector | plastic |
| Mass | approx. 10 g |

Compliance with standards and directives

| | |
|---------------------|---|
| Standard conformity | |
| Product standard | EN 60947-5-2:2007 IEC 60947-5-2:2007 |

Approvals and certificates

| | |
|------------------|--|
| EAC conformity | TR CU 020/2011 |
| Protection class | II, rated insulation voltage ≤ 250 V AC with pollution degree 1-2 according to IEC 60664-1 |
| UL approval | cULus Listed, Class 2 Power Source |
| CCC approval | CCC approval / marking not required for products rated ≤36 V |

Accessories**CPZ18B03**

Mounting Bracket with swivel nut

BF 18

Mounting flange, 18 mm

BF 18-F

Mounting flange with dead stop, 18 mm

BF 5-30

Universal mounting bracket for cylindrical sensors with a diameter of 5 ... 30 mm

V1-G-2M-PUR

Female cordset, M12, 4-pin, PUR cable

V1-W-2M-PUR

Female cordset, M12, 4-pin, PUR cable

Other suitable accessories can be found at www.pepperl-fuchs.com

Curves/Diagrams

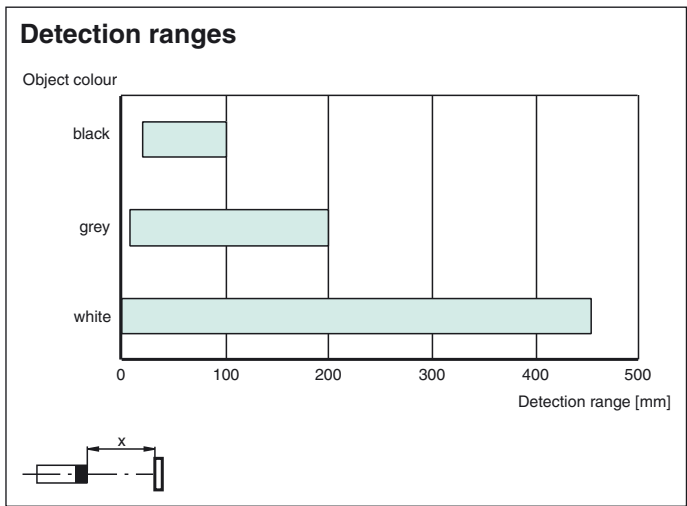
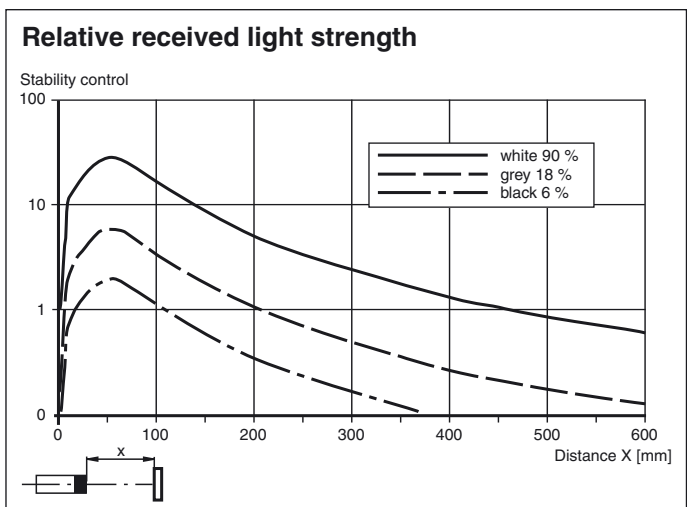
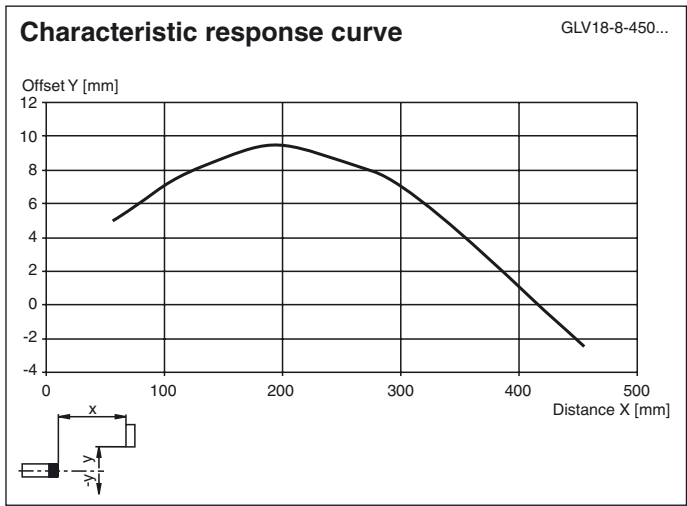

Release date: 2016-06-20 12:54 Date of issue: 2016-06-20 188567_eng.xml

Refer to "General Notes Relating to Pepperl+Fuchs Product Information".