



Model Number

UC4000-30GM-IUR2-V15

Single head system

Features

- **Parameterization interface for the application-specific adjustment of the sensor setting via the service program ULTRA 3000**
- **Analog current and voltage output**
- **Synchronization options**
- **Adjustable acoustic power and sensitivity**
- **Temperature compensation**

Diagrams

Characteristic response curve

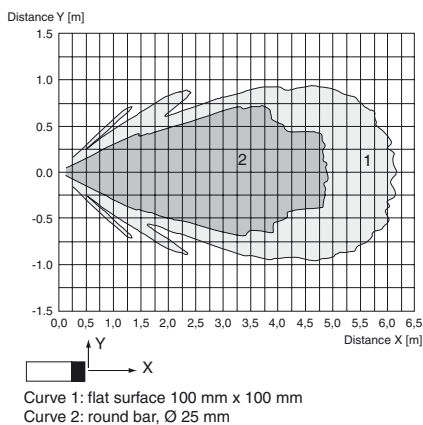

Release date: 2014-08-12 15:38 Date of issue: 2014-08-12 10:4094_eng.xml

Technical data

General specifications

Sensing range	200 ... 4000 mm
Adjustment range	240 ... 4000 mm
Unusable area	0 ... 200 mm
Standard target plate	100 mm x 100 mm
Transducer frequency	approx. 85 kHz
Response delay	145 ms minimum 440 ms factory setting

Indicators/operating means

LED green	solid: Power-on flashing: Standby mode or program function object detected
LED yellow 1	solid: object in evaluation range flashing: program function
LED yellow 2	solid: object in detection range flashing: program function
LED red	solid: temperature/program plug not connected flashing: fault or program function object not detected
Temperature/TEACH-IN connector	Temperature compensation , Evaluation range programming , output function setting

Electrical specifications

Operating voltage U_B	10 ... 30 V DC , ripple 10 % _{SS}
Power consumption P_0	≤ 900 mW

Interface

Interface type	RS 232, 9600 Bit/s , no parity, 8 data bits, 1 stop bit
----------------	---------------------------------------------------------

Input/Output

Synchronization	bi-directional 0 level: $-U_B \dots +1 V$ 1 level: $+4 V \dots +U_B$ input impedance: > 12 KOhm synchronization pulse: ≥ 100 μs, synchronization interpulse period: ≥ 2 ms
-----------------	----------------------------------------------------------------------------------------------------------------------------------------------------------------------------------------

Synchronization frequency	Common mode operation ≤ 13 Hz Multiplex operation ≤ 13 Hz / n , n = number of sensors , n ≤ 5
---------------------------	--------------------------------------------------------------------------------------------------

Output

Output type	1 current output 4 ... 20 mA 1 voltage output 0 ... 10 V
Resolution	evaluation range [mm]/4000, but ≥ 0.35 mm
Deviation of the characteristic curve	≤ 0.2 % of full-scale value
Repeat accuracy	≤ 0.1 % of full-scale value
Load impedance	current output: ≤ 500 Ohm Voltage output: ≥ 1000 Ohm
Temperature influence	≤ 2 % from full-scale value (with temperature compensation) ≤ 0.2 %/K (without temperature compensation)

Ambient conditions

Ambient temperature	-25 ... 70 °C (-13 ... 158 °F)
Storage temperature	-40 ... 85 °C (-40 ... 185 °F)

Mechanical specifications

Connection type	Connector M12 x 1 , 5-pin
Degree of protection	IP65
Material	Housing: stainless steel (1.4305 / AISI 303) PBT plastic parts
Transducer	epoxy resin/hollow glass sphere mixture; polyurethane foam
Mass	210 g

Factory settings

Output	evaluation limit A1: 500 mm evaluation limit A2: 4000 mm rising slope
--------	-----------------------------------------------------------------------------

Compliance with standards and directives

Standard conformity	Standards	EN 60947-5-2:2007 IEC 60947-5-2:2007 EN 60947-5-7:2003 IEC 60947-5-7:2003
---------------------	-----------	------------------------------------------------------------------------------------

Approvals and certificates

UL approval	cULus Listed, General Purpose
CSA approval	cCSAus Listed, General Purpose
CCC approval	CCC approval / marking not required for products rated ≤36 V

Dimensions

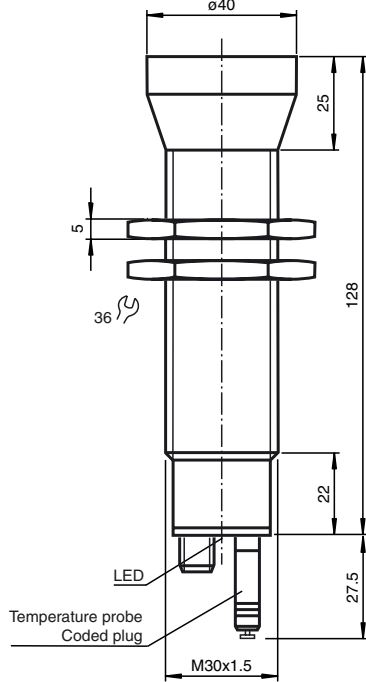

Additional Information

Analogue output function

Analogue function

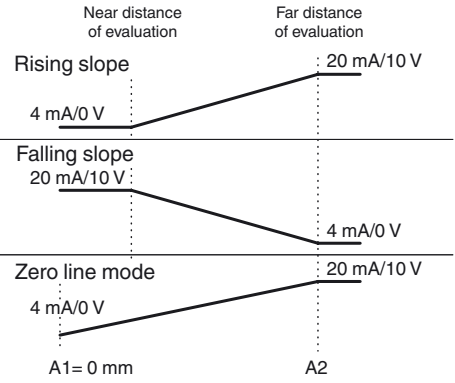

Electrical Connection

Standard symbol/Connection:
(version IU)

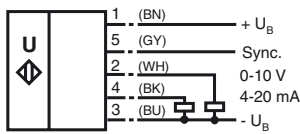

Core colors in accordance with EN 60947-5-2.

Pinout

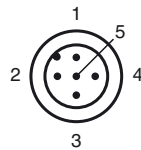

Wire colors in accordance with EN 60947-5-2

1	BN	(brown)
2	WH	(white)
3	BU	(blue)
4	BK	(black)
5	GY	(gray)

Release date: 2014-08-12 15:38 Date of issue: 2014-08-12 10:4094_eng.xml

Accessories

BF 30

Mounting flange, 30 mm

BF 30-F

Mounting flange with dead stop, 30 mm

UC-30GM-PROG

ULTRA3000

Software for ultrasonic sensors, comfort line

UC-30GM-R2

DA5-IU-2K-V

Process control and indication equipment

V15-G-2M-PVC

Female cordset, M12, 5-pin, PVC cable

V15-W-2M-PUR

Female cordset, M12, 5-pin, PUR cable

Description of Sensor Functions

Programming procedure

The sensor features 2 programmable analog outputs with programmable evaluation range. Programming the evaluation range and the operating mode is done either via the sensor's RS232 interface and ULTRA3000 software (see the ULTRA3000 software description) or by means of the programming plug at the sensor's back end which is described here.



Programming of Evaluation Range

1. Disconnect supply voltage
2. Remove the programming plug to activate program mode.
3. Reconnect supply voltage (Reset)
4. Place the target at the desired position for A1
5. Momentarily insert the programming plug in position A1 and then remove. This will program the position A1.
6. Place the target at the desired position for A2
7. Momentarily insert the programming plug in position A2 and then remove. This will program the position A2.

Notes:

- Removing the programming plug saves the new position into the device memory.
- The programming status is indicated by the LED. A flashing green LED indicates that the target is detected; a flashing red LED indicates that no target is detected.

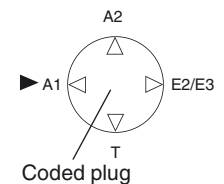

Programming the Operation Mode

If the program mode is still activated, continue at number 4. If not, activate program mode by performing the sequence numbers 1 to 3.

1. Disconnect supply voltage
2. Remove the programming plug to activate program mode.
3. Reconnect supply voltage (Reset)
4. Insert the programming plug in position E2/E3. By removing and reinserting the plug, the user can toggle through the three different modes of operation. The selected mode is indicated by the LEDs as shown below:
 - Rising slope mode, LED A2 flashes
 - Falling slope mode, LED A1 flashes
 - Zero line mode, LEDs A1 and A2 flash
5. Once the desired mode is selected, insert the programming plug in position T. This completes the programming procedure and saves the switch points and mode of operation.
6. The sensor now operates in normal mode.

Note:

The programming plug also functions as the temperature compensation. If the programming plug has not been inserted in the T position within 5 minutes, the sensor will return to normal operating mode with the latest saved values, without temperature compensation.

Factory settings

See technical data.

Display

The sensor provides LEDs to indicate various conditions.

Release date: 2014-08-12 15:38 Date of issue: 2014-08-12 104094_eng.xml

	Green LED	Red LED	Yellow LED A1	Yellow LED A2
During Normal Operation				
- Temperature compensated	On	Off	Object in evaluation range	Object in sensing range
- with removed programming plug	Off	On	Object in evaluation range	Object in sensing range
Interference (e.g. compressed air)	Off	Flashing	remains in previous state	remains in previous state
During Sensor Programming				
Evaluation limit A1:				
Object detected	Flashing	Off	Flashing	Off
No object detected	Off	Flashing	Flashing	Off
Evaluation limit A2:				
Object detected	Flashing	Off	Off	Flashing
No object detected	Off	Flashing	Off	Flashing
Operation mode:				
Rising slope mode	On	Off	Off	Flashing
Falling slope mode	On	Off	Flashing	Off
Zero line mode	On	Off	Flashing	Flashing
Standby	Flashing	Off	remains in previous state	remains in previous state

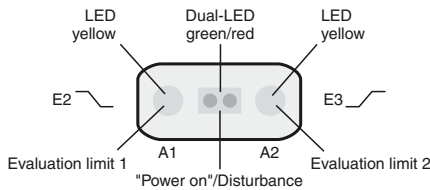

Synchronization

This sensor features a synchronization input for suppressing ultrasonic mutual interference ("cross talk"). If this input is not connected, the sensor will operate using internally generated clock pulses. It can be synchronized by applying an external square wave. The pulse duration must be ≥ 100 μs. Each falling edge of the synchronization pulse triggers transmission of a single ultrasonic pulse. If the synchronization signal remains low for ≥ 1 second, the sensor will revert to normal operating mode. Normal operating mode can also be activated by opening the signal connection to the synchronization input (see note below).

If the synchronization input goes to a high level for > 1 second, the sensor will switch to standby mode, indicated by the green LED. In this mode, the outputs will remain in the last valid output state.

Note:

If the option for synchronization is not used, the synchronization input has to be connected to ground (0 V) or the sensor must be operated via a V1 cordset (4-pin).

The synchronization function cannot be activated during programming mode and vice versa.

The following synchronization modes are possible:

- Several sensors (max. number see technical data) can be synchronized together by interconnecting their respective synchronization inputs. In this case, each sensor alternately transmits ultrasonic pulses in a self multiplexing mode. No two sensors will transmit pulses at the same time (see note below).
- Multiple sensors can be controlled by the same external synchronization signal. In this mode the sensors are triggered in parallel and are synchronized by a common external synchronization pulse.
- A separate synchronization pulse can be sent to each individual sensor. In this mode the sensors operate in external multiplex mode (see note below).
- A high level (+U_B) on the synchronization input switches the sensor to standby mode.

Note:

Sensor response times will increase proportionally to the number of sensors that are in the synchronization string. This is a result of the multiplexing of the ultrasonic transmit and receive signal and the resulting increase in the measurement cycle time.

Note on communication with the UC-30GM-R2 interface cable

The UC-30GM-R2 interface cable allows for communication with the ultrasonic sensor using ULTRA3000 software. The cable creates a connection between a PC RS-232 interface and the programming plug socket on the sensor. When connecting to the sensor, make certain the plug is lined up correctly; otherwise no communication will be possible. The key of the cable's plug must be aligned to the groove of the socket on the sensor (not with the arrow symbol on the sensor).

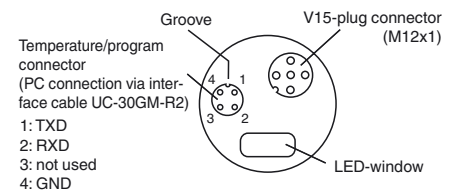

Programmable parameters with the ULTRA3000 software

- Evaluation limits A1 and A2
- Operation mode
- Sonic speed
- Temperature offset (The inherent temperature-rise of the sensor can be considered in the temperature compensation)
- Expansion of the unusable area (for suppression of unusable area echoes)
- Reduction of the detection range (for suppression of remote range echoes)
- Time of measuring cycle
- Acoustic power (interference of the burst duration)
- Sensitivity
- Behavior of the sensor in case of echo loss
- Behavior of the sensor in case of a fault
- Average formation via an allowed number of measuring cycles
- Selection of the parameter set, RS 232 or manually

Note:

When connected to a PC and running the ULTRA3000 software, the sensor can act as a long term data logger as well.

Release date: 2014-08-12 15:38 Date of issue: 2014-08-12 10:094_eng.xml

Installation conditions

If the sensor is installed in an environment where the temperature can fall below 0 °C, one of these mounting flanges must be used for mounting: BF30, BF30-F, or BF 5-30.

If the sensor is mounted in a through hole using the included steel nuts, it must be mounted at the middle of the threaded housing. If it must be mounted at the front end of the threaded housing, plastic nuts with centering ring (optional accessories) must be used.